

Ringbock schweißbar VRBS



Safety instructions

This safety instruction/declaration of the manufacturer has to be kept on file for the whole lifetime of the product.

- Translation of the Original instructions -

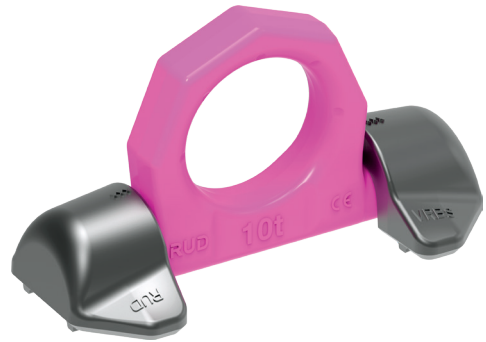

Load ring - **VRBS** - for welding



RUD Ketten
Rieger & Dietz GmbH u. Co. KG

RUD-Art.-Nr.: 8502954/07.018



EG-Konformitätserklärung

entsprechend der EG-Maschinenrichtlinie 2006/42/EG, Anhang II A und ihren Änderungen

Hersteller: **RUD Ketten**
Rieger & Dietz GmbH u. Co. KG
Friedensinsel
73432 Aalen

Hiermit erklären wir, dass die nachfolgend bezeichnete Maschine aufgrund ihrer Konzipierung und Bauart, sowie in der von uns in Verkehr gebrachten Ausführung, den grundlegenden Sicherheits- und Gesundheitsanforderungen der EG-Maschinenrichtlinie 2006/42/EG sowie den unten aufgeführten harmonisierten und nationalen Normen sowie technischen Spezifikationen entspricht.
Bei einer nicht mit uns abgestimmten Änderung der Maschine verliert diese Erklärung ihre Gültigkeit.

Produktbezeichnung: Ringbock
VRBS-fix / VRBK-fix / VRBS / VRBG / VRBK / VRBSS

Folgende harmonisierten Normen wurden angewandt:

DIN EN 1677-1 : 2009-03	DIN EN ISO 12100 : 2011-03

Folgende nationalen Normen und technische Spezifikationen wurden außerdem angewandt:

BGR 500, KAP2.8 : 2008-04	

Für die Zusammenstellung der Konformitätsdokumentation bevollmächtigte Person:
Michael Betzler, RUD Ketten, 73432 Aalen

Aalen, den 26.09.2016 Dr.-Ing. Arne Kriegsmann, (Prokurist/QMB) *Arne Kriegsmann*
Name, Funktion und Unterschrift Verantwortlicher



EC-Declaration of conformity

According to the EC-Machinery Directive 2006/42/EC, annex II A and amendments

Manufacturer: **RUD Ketten**
Rieger & Dietz GmbH u. Co. KG
Friedensinsel
73432 Aalen

We hereby declare that the equipment sold by us because of its design and construction, as mentioned below, corresponds to the appropriate, basic requirements of safety and health of the corresponding EC-Machinery Directive 2006/42/EC as well as to the below mentioned harmonized and national norms as well as technical specifications.
In case of any modification of the equipment, not being agreed upon with us, this declaration becomes invalid.

Product name: Load ring
VRBS-fix / VRBK-fix / VRBS / VRBG / VRBK / VRBSS

The following harmonized norms were applied:

DIN EN 1677-1 : 2009-03	DIN EN ISO 12100 : 2011-03

The following national norms and technical specifications were applied:

BGR 500, KAP2.8 : 2008-04	

Authorized person for the configuration of the declaration documents:
Michael Betzler, RUD Ketten, 73432 Aalen

Aalen, den 26.09.2016 Dr.-Ing. Arne Kriegsmann, (Prokurist/QMB) *Arne Kriegsmann*
Name, function and signature of the responsible person

ENGLISH User Instructions

- Reference should be made to German Standards according DGUV 100-500 or other country specific statutory regulations and inspections are to be carried out by competent persons only.
- Before installing and every use, visually inspect RUD lifting points, paying particular attention to any evidence of weld cracks, corrosion, wear, deformations, etc.
- The material construction to which the lifting point will be attached should be of adequate strength to withstand forces during lifting without deformation. The contact areas must be free from impurities, oil, colour, etc.

The material of the forged welding block is S355J2+N (St52-3 1.0577+N), B.S. 4360.50 D or AISI 1019

- The lifting points must be positioned on the load in such a way that movement is avoided during lifting.
 - For single leg lifts, the lifting point should be vertically above the centre of gravity of the load.
 - For two leg lifts, the lifting points must be equidistant to/or above the centre of gravity of the load.
 - For three and four leg lifts, the lifting points should be arranged symmetrically around the centre of gravity in the same plane.

5. Load Symmetry:

The working load limits of individual RUD lifting points are calculated using the following formula and are based on symmetrical loading:

$$W_{LL} = \frac{G}{n \times \cos \beta}$$

W_{LL} = working load limit
 G = load weight (kg)
 n = number of load bearing legs
 β = angle of inclination of the chain to the vertical

The calculation of load bearing legs is as follows:

	symmetrical	asymmetrical
two leg	2	1
three / four leg	3	1

(see table 1+ 5)

- All fittings connected to the VRBS should be free moving. When connecting and disconnecting the lifting means (sling chain) pinches and impacts should be avoided. Damage of the lifting means caused by sharp edges should be avoided as well.

A non-adherence to this advice may result damages of persons and materials!

- Suitability of temperature use: RUD-Lifting points VRBS are suitable for the temperature range from -20°C up to 400°C. For the use within the following temperature range, the WLL must be reduced by the following factors:
 200°C up to 300°C: by -10 % and
 300°C up to 400°C: by -25 %

The lifting points VRBS can be stress-relieved one-time in an unloaded condition, together with the load (e.g. welded construction): Temperature < 600°C (1100°F)
 The evidence of the suitability of the used weld metal must be mentioned by the respective filler material manufacturer.

- The distance lugs assist in achieving the correct root weld (approx. 3 mm = 0.1 inch). They may not be removed.
- RUD-Lifting points must not be used under chemical influences such as acids, alkaline solutions and vapours e.g. in pickling baths or hot dip galvanising plants. If this cannot be avoided, please contact the manufacturer indicating the concentration, period of penetration and temperature of use.
- The places where the lifting points are fixed should be marked with colour. The load ring of the VRBS is pink powder coated.
- If the lifting points are used **exclusively** for lashing the value of the working load limit can be doubled. LC = 2 x WLL
- After welding, an annual inspection or sooner if conditions dicate should be undertaken by a competent person examining the continued suitability. Also after damage and special occurrences.

Inspection criteria concerning paragraphs 2 and 12:

- The lifting point should be complete.
- The working load limit and manufacturers stamp should be clearly visible.
- Deformation of the component parts such as body and load ring.
- Mechanical damage, such as notches, particulary in high stress areas.
- Wear should be no more than 10 % of cross sectional diameter.
- Evidence of corrosion.
- Cracks or other damage to the weld.

Method of lift										
Number of legs	1	1	2	2	2	2	2	3 & 4	3 & 4	3 & 4
Angle d' inclinaison β	0°	90°	0°	90°	0-45°	45-60°	unsymm.	0-45°	45-60°	unsymm.
Factor	1	1	2	2	1.4	1	1	2.1	1.5	1
Type	max weight of load in metric tonnes									
	4 t	4 t	8 t	8 t	5.6 t	4 t	4 t	8.4 t	6 t	4 t
	6.7 t	6.7 t	13.4 t	13.4 t	9.4 t	6.7 t	6.7 t	14.1 t	10 t	6.7 t
	10 t	10 t	20 t	20 t	14 t	10 t	10 t	21.2 t	15 t	10 t
	16 t	16 t	32 t	32 t	22.4 t	16 t	16 t	33.6 t	24 t	16 t
	31.5 t	31.5 t	63 t	63 t	45 t	31.5 t	31.5 t	67 t	47.5 t	31.5 t
	50 t	50 t	100 t	100 t	70 t	50 t	50 t	105 t	75 t	50 t

Table 1 ♦ = Model in RUD Octagon-shape design (changeover from 2018)

Subject to technical alterations

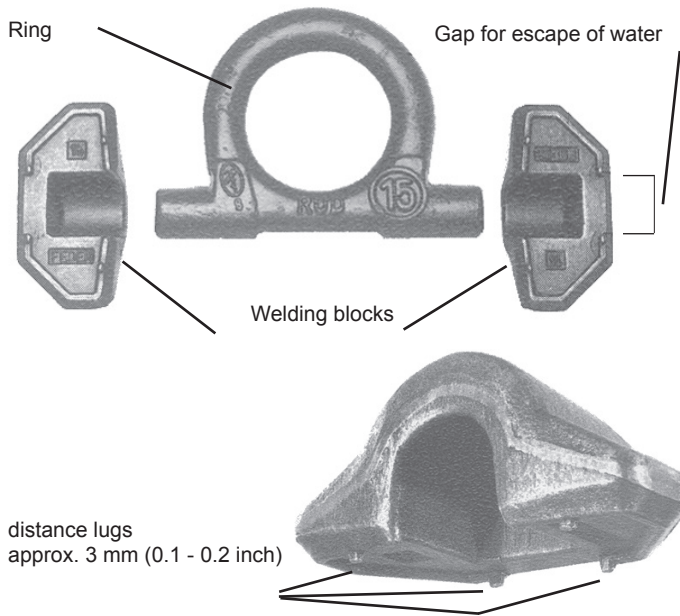

weld size (per welding block):

	weld		
	size	length	volume
VRBS 4 t	HY 4 + a 3 \triangle	2 x 130 mm	approx. 4,5 cm ³
VRBS 6,7 t	HY 5,5 + a 3 \triangle	2 x 170 mm	approx. 9 cm ³
VRBS 10 t	HY 6 + a 4 \triangle	2 x 190 mm	approx. 11 cm ³
VRBS 16 t	HY 8,5 + a 4 \triangle	2 x 250 mm	approx. 26 cm ³
VRBS 31,5 t	HY 18 + a 4 \triangle	2 x 365 mm	approx. 88 cm ³
VRBS 50 t	HY 25 + a 8 \triangle	2x 655 mm	approx. 450 cm ³

Table 3

Welding procedure + Welding filler metals:

	Europa (DE, GB, FR,)	USA, Canada, ..
	Mild steel, Low alloyed steel	
MAG/MIG (135) GAS SHIELDED WIRE WELDING	ISO 14341: G4 Si 1 z.B. Castolin 45250	ISO 14341: G4 Si 1 AWS A 5.18 : ER 70 S-6 z.B. Eutectic MIG-Tec Tic A88
E-Hand Gleichstrom = (111) Stick Electrode Direct Current	EN ISO 2560-A - E 42 6 B 3 2; EN ISO 2560-A - E 38 2 B 12 H10 z.B. Castolin 6666 * Castolin 6666 N*	AWS A 5.5 : E 8018-G AWS A 5.5 : E 7016 EN ISO 2560-A - E 42 6 B 3 2; EN ISO 2560-A - E 38 2 B 12 H10 z.B. Eutectic 6666/ 35066 CP *
E-Hand Wechselstrom (111) Stick Electrode Alternating Current	EN ISO 2560-A - E 38 0 RR 1 2 EN ISO 2560-A - E 42 0 RR 1 2; z.B. Castolin 6600 Castolin 35086 no-load-voltage 35-48 (max.) V	AWS A 5.1 : E 6013 EN ISO 2560-A - E 38 0 RR 1 2 EN ISO 2560-A - E 42 0 RR 1 2; z.B. Eutectic Beauty Weld II
WIG (141) TIG Tungsten Arc Welding	ISO 636: W3 Si 1 z.B. Castolin 45255W	ISO 636: W3 Si 1 AWS A 5.18 : ER 70 S-6 z.B. Eutectic TIG-Tec-Tic: A 88

Table 2 * Follow the drying instructions!

The specific processing informations of the welding fillers have to be attended.

Seam welding definition:

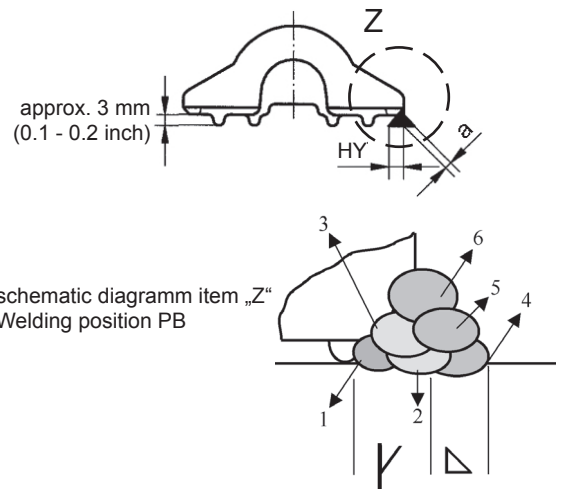

schematic diagram item „Z“
Welding position PB



For welding the VRBS 31.5 & VRBS 50 the **preheat temperature** has to be between 150° & 170° C.

Ring integrated in the construction:

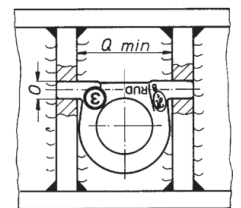

Type	WLL t	weight kg	A	B	C	D	E	F	T	O	Q	reference		
												VRBS	Ring	Welding block
VRBS 4 t	4	0.9	62	14	28	48	135	71	65	19 ^{+0.5}	77 ⁺¹	7992826*	7991922	7992004
VRBS 6.7 t	6.7	2.1	88	20	39	60	170	92	84	25 ^{+0.5}	101 ⁺¹	7992827*	7991923	7992005
VRBS 10 t	10	3.0	100	22	46	65	195	100	95	30 ^{+0.5}	106 ⁺¹	7992828**	7991890	7992007
VRBS 16 t	16	6.9	130	30	57	90	263	134	127	38 ^{+0.5}	147 ⁺²	7992491	7906893	7992008
VRBS 31.5 t	31.5	15.6	160	42	79	130	375	195	178	50 ^{+0.5}	222 ⁺²	60267	7901639	7987160
VRBS 50 t	50	54	240	70	120	230	620	340	313	65 ^{+0.5}	375 ⁺²	56834	7907412	7987161

Table 4

* = Packing unit/Conditionnement: 10 pcs
** = Packing unit: 4 pcs

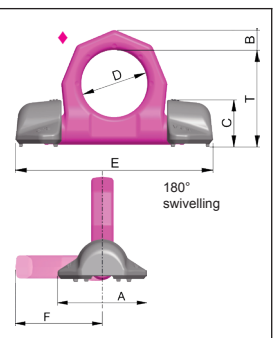



Hint

For welding the VRBS 31.5 & VRBS 50 the **preheat temperature** has to be between **150° and 170° C**.

Do **not weld** at the pink powder coated, **heat treated load ring**.

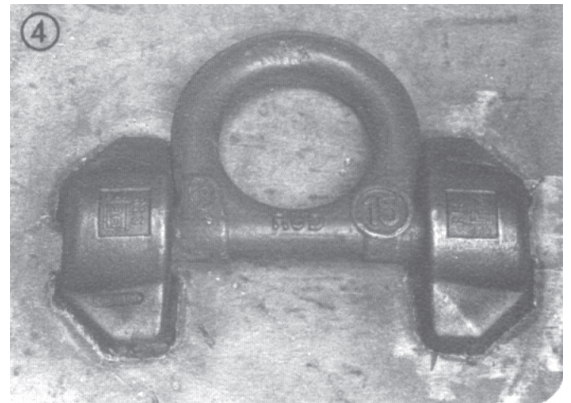
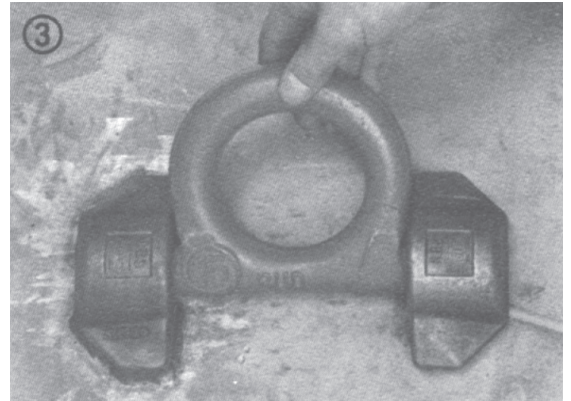
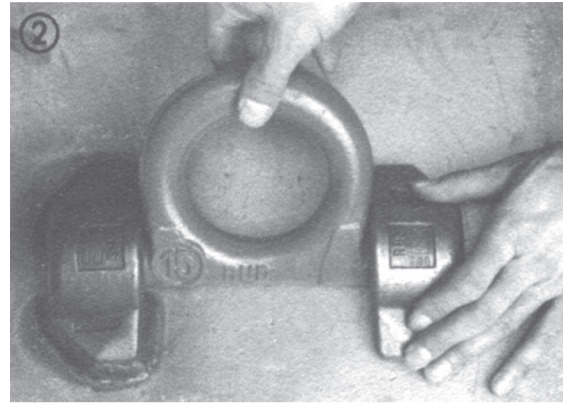
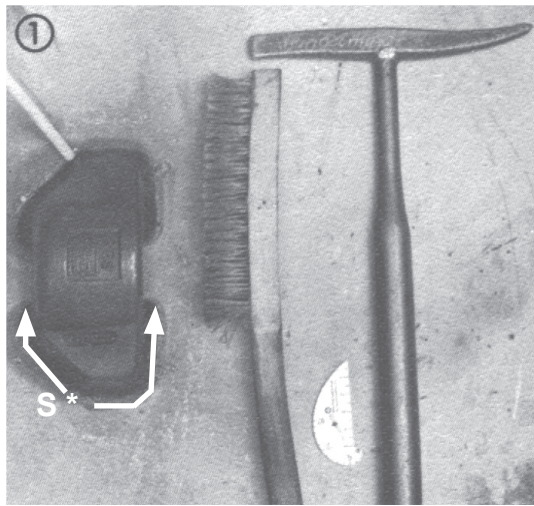

ENGLISH

The welding should only be carried out according to DIN EN ISO 9606-1 or AWS Standards by an authorized welder.

Welding sequence:

- ① Welding of the block. The distance lugs assist in achieving the correct air gap for the root of seam weld (approx. 3 mm, or 1/8") Lugs must not be removed! Start welding of root seam and top run at point „S“ (see drawing). Before carrying out roof weld (top run), carefully clean root of seam. Append fillet weld (measurement „a“) acc. Chart 3. The whole welding should be carried out at the same temperature. Do not interrupt welding. Keep area of water outlet open.
- ② Insert ring in welded welding block. Attach second welding block as tight as possible to the ring, in order to still guarantee moveability of same. Only fasten provisionally.
- ③ Examine on 180° tilting ability. Possibly make corrections.
- ④ Weld on second welding block, as described under ①.

Method of lift										
Number of legs	1	1	2	2	2	2	2	3 & 4	3 & 4	3 & 4
Angle of inclination α	0°	90°	0°	90°	0-45°	45-60°	unsymm.	0-45°	45-60°	unsymm.
Factor	1	1	2	2	1.4	1	1	2.1	1.5	1
Type	max weight of load in lbs									
VRBS 4 t	8800 lbs	8800 lbs	17600 lbs	17600 lbs	12320 lbs	8800 lbs	8800 lbs	18480 lbs	13200 lbs	8800 lbs
VRBS 6.7 t	14750 lbs	14750 lbs	29500 lbs	29500 lbs	20650 lbs	14750 lbs	14750 lbs	30900 lbs	22000 lbs	14750 lbs
VRBS 10 t	22000 lbs	22000 lbs	44000 lbs	44000 lbs	30800 lbs	22000 lbs	22000 lbs	46200 lbs	33000 lbs	22000 lbs
VRBS 16 t	35200 lbs	35200 lbs	70400 lbs	70400 lbs	49300 lbs	35200 lbs	35200 lbs	74000 lbs	52800 lbs	35200 lbs
VRBS 31.5 t	69300 lbs	69300 lbs	138600 lbs	138600 lbs	97000 lbs	69300 lbs	69300 lbs	145500 lbs	104000 lbs	69300 lbs
VRBS 50 t	110000 lbs	110000 lbs	220000 lbs	220000 lbs	154000 lbs	110000 lbs	110000 lbs	231000 lbs	165000 lbs	110000 lbs

Table 5

◆ = Model in RUD Octagon-shape design (changeover from 2018)

Subject to technical alterations